

- Low Noise: $7 \mu\text{g}/\sqrt{\text{Hz}}$ typical for 2g Full Scale Version
- High Stability
- -55 to +175°C Operation
- $\pm 4\text{V}$ Differential Output
- +5 VDC, 5 mA Power (Typical)
- Responds to DC and AC Acceleration
- Integrated Sensor & Amplifier
- Internal Temperature Sensor
- Nitrogen Damped & Hermetically Sealed
- Serialized for Traceability
- Pin Compatible with Models 1221 and 1521
- RoHS Compliant

AVAILABLE G-RANGES

FULL SCALE ACCELERATION	20 PIN JLCC
$\pm 2 \text{ g}$	1531J-002
$\pm 5 \text{ g}$	1531J-005
$\pm 10 \text{ g}$	1531J-010
$\pm 25 \text{ g}$	1531J-025
$\pm 50 \text{ g}$	1531J-050
$\pm 100 \text{ g}$	1531J-100
$\pm 200 \text{ g}$	1531J-200
$\pm 400 \text{ g}$	1531J-400

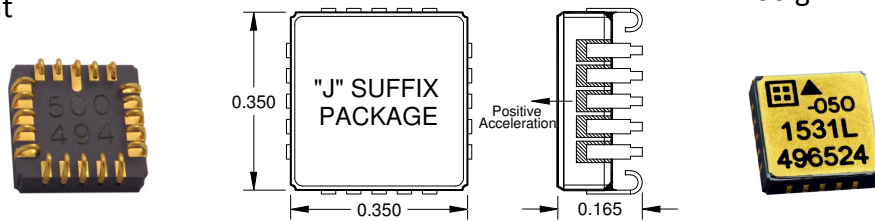

DESCRIPTION

The Model 1531 is a low-cost, integrated accelerometer for use in zero to medium frequency instrumentation applications that require extremely low noise and reliable long-term stability. The 1531 was designed to support the harsh conditions of down hole drilling, and the 2g version is ideally suited for tilt and seismic applications. Each miniature, hermetically sealed package combines a micro-machined capacitive sense element and a custom integrated circuit that includes a sense amplifier and differential output stage. It is relatively insensitive to temperature changes and gradients. Each device is marked with a serial number on its top and bottom surfaces for traceability. An optional calibration test sheet (1531-TST) is also available which lists the measured bias, scale factor, linearity, operating current and frequency response. LCC package available by special order.

ZERO (DC) TO MEDIUM FREQUENCY APPLICATIONS



PERFORMANCE

INPUT RANGE	FREQUENCY RESPONSE (MINIMUM, 3 DB)	SENSITIVITY, DIFFERENTIAL	OUTPUT NOISE, DIFFERENTIAL (RMS, TYPICAL)	MAX. MECHANICAL SHOCK (0.1 MS)
g	Hz	mV/g	$\mu\text{g}/(\text{root Hz})$	g (peak)
± 2	0 – 300	2000	7	2000
± 5	0 – 400	800	12	
± 10	0 – 600	400	18	
± 25	0 – 900	160	25	
± 50	0 – 1200	80	50	5000
± 100	0 – 1400	40	100	
± 200	0 – 1750	20	200	
± 400	0 – 2000	10	400	

By Model: $V_{DD}=V_R=5.0 \text{ VDC}$, $T_C=25^\circ\text{C}$.

SPECIFICATIONS SUBJECT TO CHANGE WITHOUT NOTICE

PERFORMANCE - ALL VERSIONS

All Models: Unless otherwise specified $V_{DD}=V_R=5.0$ VDC, $T_C=25^\circ\text{C}$, Differential. Span = $\pm g$ range = 8000 mV

PARAMETER	MIN	TYP	MAX	UNITS
Bias Calibration Error ¹		0.2	0.5	\pm % of span
Bias Temperature Shift ($T_C = -55$ to $+125^\circ\text{C}$) ¹	-200	0	+200	(PPM of span)/ $^\circ\text{C}$
Scale Factor Calibration Error ^{1,3}		0.5	1	\pm %
Scale Factor Temperature Shift ($T_C = -55$ to $+125^\circ\text{C}$) ¹	-200	0	+200	PPM/ $^\circ\text{C}$
Non-Linearity (-90 to +90% of Span) ^{1,3}		0.15	0.5	\pm % of span
Long Term Bias Stability		1000	2000	\pm PPM of span
Long Term Scale Factor Stability		500	1000	\pm PPM
Cross Axis Sensitivity		2	3	\pm %
Input Axis Misalignment		5	10	\pm mrad
Turn-On Transient (in less than 0.5ms)		75		\pm PPM of FS
Output Impedance		90		Ohms
Operating Voltage ⁴	4.75	5.0	5.25	volts
Operating Current (IDD+IVR)		5	6	mA
Mass: 'L' package (add 0.06 grams for 'J' package)		0.62		grams

MAXIMUM RATINGS *

Case Operating Temperature ²	-55 to +175 $^\circ\text{C}$
Storage Temperature ²	-55 to +175 $^\circ\text{C}$
Voltage on V_{DD} to GND	-0.5V to 6.5V
Voltage on Any Pin (except DV) to GND ⁴	-0.5V to $V_{DD}+0.5V$
Voltage on DV to GND (Self-Test)	$\pm 15V$
Power Dissipation	50 mW

Note 1: Tighter tolerances may be available on special order.

Note 2: Minimize exposure above 150 $^\circ\text{C}$ for maximum lifespan.

Note 3: For 2g thru 50g only; 100g and greater versions are tested and specified from -65 to +65g.

Note 4: Voltages on pins other than DV, GND or V_{DD} may exceed 0.5 volt above or below the supply voltages provided the current is limited to 1 mA.

*** NOTICE:** Stresses greater than those listed above may cause permanent damage to the device. These are maximum stress ratings only. Functional operation of the device at or above these conditions is not implied. Exposure to absolute maximum rating conditions for extended periods may affect device reliability and lifespan.

OPERATION

The model 1531 sensitive axis is perpendicular to the bottom of the package, with positive acceleration resulting from a positive force pushing on the bottom of the package. The seismic center is located on a centerline through the dual sense elements and halfway between them. The internal electronics effectively cancel any errors due to rotation. Two reference voltages, +5.0 and +2.5 volts (nominal), are required; scale factor is ratiometric to the +5.0 volt reference voltage relative to GND, and both outputs at zero acceleration are nominally 80 mV below the +2.5 volt input.

The Model 1531 produces a differential +/-4 volts output voltage or single ended mode, 0.5 – 4.5 volts full scale, the value of which varies with acceleration as shown in the figures below.

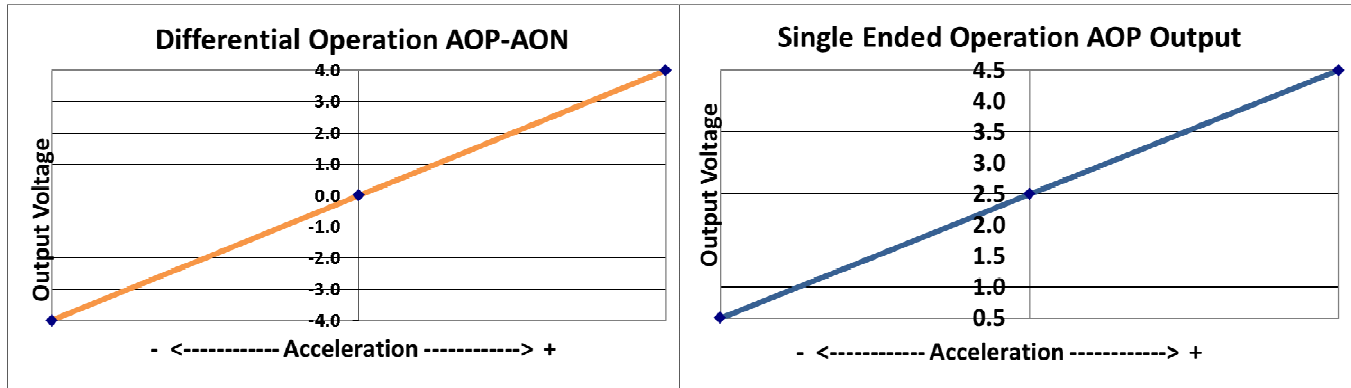

SIGNAL DESCRIPTIONS

V_{DD} and GND (power): Pins (14) and (19) respectively. Power (+5 Volts DC) and ground.

AOP and AON (output): Pins 12 and 16 respectively. Analog output voltages proportional to acceleration. The AOP voltage increases (AON decreases) with positive acceleration; at zero acceleration both outputs are nominally equal to the +2.5 volt reference. The device experiences positive (+1g) acceleration with its lid facing up in the earth's gravitational field. Use of differential mode is strongly recommended for both lowest noise and highest accuracy operation. Voltages can be measured ratio-metrically to VR for good repeatability without requiring a separate precision reference voltage for an A/D.

DV (input): Pin 4. Deflection Voltage. A test input that applies an electrostatic force to the sense element, simulating a positive acceleration. The nominal voltage at this pin is ½ V_{DD}. DV voltages higher than required to bring the output to positive full scale may cause device damage.

VR (input): Pin 3. Voltage Reference. Tie to a good reference (not directly to VDD) for best scale factor repeatability. A 0.1µF bypass capacitor is recommended at this pin. VR current is less than 100 uA.

2.5 Volt (input): Pin 17. Sets internal and output common mode value. Tie to a resistive voltage divider from +5 volts. A 0.1µF bypass capacitor is recommended at this pin.

I_T (output): Pin 8. Temperature dependent current source. May be tied to V_{DD} if not used.

Special Use Pins: Pins 9 and 11 should be tied to VDD, Pins 2, 5, 6, and 18 to GND.

**** Pins 1, 7, 10, 13, 15, and 20 are reserved for future use and should remain unused ****

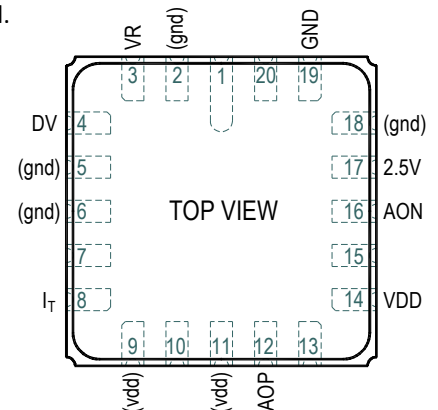

RECOMMENDED CONNECTIONS

DEFLECTION VOLTAGE (DV) TEST INPUT: This test input applies an electrostatic force to the sense element, simulating a positive acceleration. It has a nominal input impedance of 32 kΩ and a nominal open circuit voltage of ½ V_{DD}. For best accuracy during normal operation, this input should be left unconnected or connected to a voltage source equal to ½ of the V_{DD} supply. The change in differential output voltage (AOP - AON) is proportional to the square of the difference between the voltage applied to the DV input (V_{DV}) and ½ V_{DD}. Only positive shifts in the output voltage may be generated by applying voltage to the DV input. When voltage is applied to the DV input, it should be applied gradually. The application of DV voltages greater than required to bring the output to positive full scale may cause device damage. The proportionality constant (*k*) varies for each device and is not characterized.

$$\Delta(AOP - AON) \approx k \left(V_{DV} - \frac{1}{2} V_{DD} \right)^2$$

The 2.5V input (pin 17) may be driven from a resistive divider.

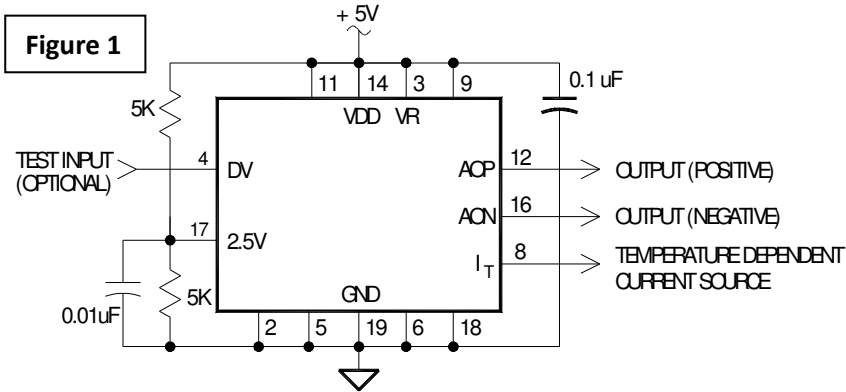

ESD and LATCH-UP CONSIDERATIONS: The model 1531 accelerometer is a CMOS device subject to damage from large electrostatic discharges. Diode protection is provided on the inputs and outputs, and it is not easily damaged, but care should be exercised during handling. However, individuals and tools should be grounded before coming in contact with the device. Although the 1531 is resistant to latch-up, inserting a 1531 into or removing it from a powered socket may cause damage.

INTERNAL TEMPERATURE SENSING

The models 1521 and 1531 accelerometers contains a temperature dependent current source that is output on pin 8. This signal is useful for measuring the internal temperature of the accelerometer so that any previously characterized bias and scale factor temperature dependence, for a particular accelerometer, can be corrected. The nominal output current at 25°C is $\approx 500 (\pm 200) \mu A$ and the nominal sensitivity is $1.5 (\pm 0.5) \mu A/^{\circ}C$. Fluctuations in V_{DD} & V_R have little effect on the temperature reading. A reduction of 0.10V to both V_{DD} & V_R will reduce the current about $1 \mu A$, which corresponds to less than a $1^{\circ}C$ change in reading. With a single resistor $R_T = 2K$ between I_T (pin 8) and GND the output voltage V_T will vary between +0.76 and +1.3 volts from -55 to $+125^{\circ}C$, which equates to a sensitivity of $\approx +3 mV/^{\circ}C$.

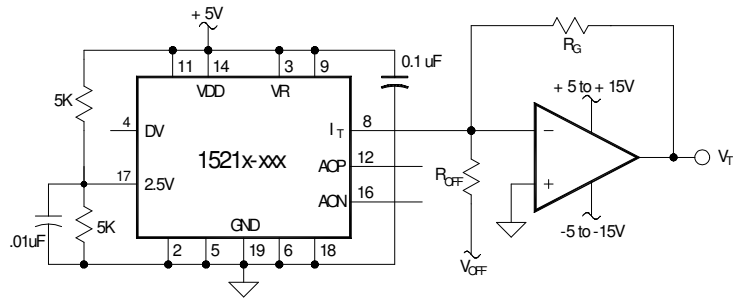

FIGURE 2

$$V_T \approx R_T [(500 \mu A) + [(1.5 \mu A)(T - 25)]]$$

$$\frac{\Delta V_T}{\Delta T} = R_T (1.5 \mu A)$$

If a greater voltage change versus temperature or lower signal source impedance is needed, add the amplifier as shown on the right side in Figure 2. With offset voltage $V_{OFF} = -5V$, gain resistor $R_G = 15.0K$ and offset resistor $R_{OFF} = 7.32K$, the output voltage V_T will vary between +4.5 and +0.5 Volts from -55 to $+125^{\circ}C$, which equates to a sensitivity of $\approx -29 mV/^{\circ}C$.

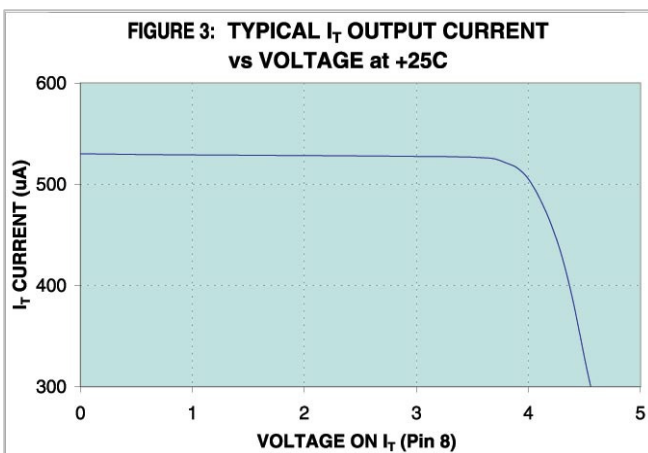

FIGURE 3: TYPICAL I_T OUTPUT CURRENT vs VOLTAGE at +25C

$$V_T \approx -R_G \left[\frac{V_{OFF}}{R_{OFF}} + (500 \mu A) + [(1.5 \mu A)(T - 25)] \right]$$

$$R_{OFF} = \frac{-V_{OFF}}{\left(\frac{V_T}{R_G} \right) + (500 \mu A) + [(1.5 \mu A)(T - 25)]}$$

$$\frac{\Delta V}{\Delta T} = -R_G (1.5 \mu A)$$

$$R_G = \frac{-\Delta V_T}{(1.5 \mu A)(\Delta T)}$$

Figure 3 shows the voltage compliance of the temperature dependent current source (I_T) at room temperature. The voltage at pin 8 must be kept in the 0 to +3V range in order to achieve proper temperature readings.

PACKAGE DIMENSIONS

- *Dimensions "M," "T," and "U" locate sensing element's center of mass.
- Lid is electrically tied to terminal 19 (GND).
- Controlling dimension: Inch.
- Terminals are plated with 60 microinches min gold over 80 microinches min nickel. This plating specification does not apply to the Pin-1 identifier mark on the bottom of the J-lead package version.
- Package: 90% min alumina (black), lid: solder sealed kovar.

Dim	Inches		Millimeters	
	Min	Max	Min	Max
A	0.342	0.358	8.69	9.09
B	0.346	0.378	8.79	9.60
C	0.055 TYP		1.40 TYP	
D	0.095	0.115	2.41	2.92
E	0.085 TYP		2.16 TYP	
F	0.050 BSC		1.27 BSC	
G	0.025 TYP		0.64 TYP	
H	0.050 TYP		1.27 TYP	
J	0.004 x 45°		0.10 x 45°	
K	0.010 R TYP		0.25 R TYP	
L	0.016 TYP		0.41 TYP	
* M	0.048 TYP		1.23 TYP	
N	0.050	0.070	1.27	1.78
P	0.017 TYP		0.43 TYP	
R	0.023 R TYP		0.58 R TYP	
* T	0.085 TYP		2.16 TYP	
* U	0.175 TYP		4.45 TYP	

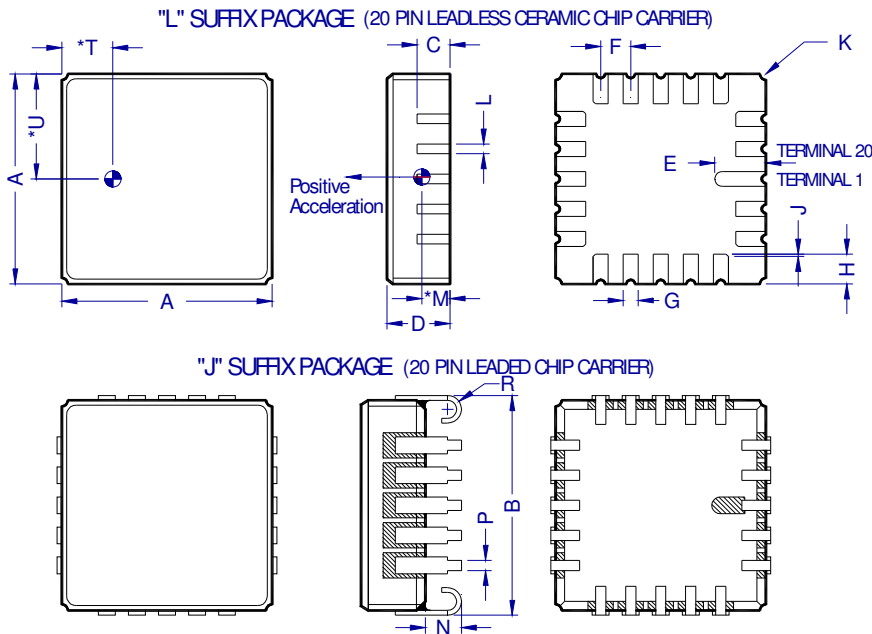

SOLDERING RECOMMENDATIONS

RoHS Compliance: The model 1531 does not contain elemental lead and is RoHS compliant.

Pre-Tinning of Accelerometer Leads is Recommended: To prevent gold migration embrittlement of the solder joints, it is best to pre-tin the accelerometer leads.

LCC Solder Contact Plating Information: The plating composition and thickness for the solder pads and castellations on the "L" suffix (LCC) package are 60 to 225 micro-inches thick of gold (Au) over 80 to 350 micro-inches thick of nickel (Ni) over a minimum of 5 micro-inches thick of molybdenum or tungsten refractory material. The J-Lead package top layer is 100 to 225 microinches thick of 99.7% gold (Au) over 80 to 350 microinches thick of electroplated nickel (Ni).

Do not use ultrasonic cleaners.

Ultrasonic cleaning will void the warranty and may break internal wire bonds.

DIM	Inch	mm
A	.230	5.84
B	.430	10.92
C	.100	2.54
D	.033	0.84
E	.050	1.27
F	.013	0.33
G	.120	3.05

