

High Speed Current Amplifier

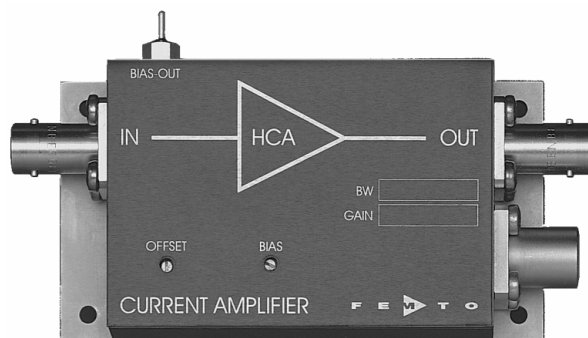

<p>Features</p>	<ul style="list-style-type: none"> • Bandwidth and Frequency Response Independent of Detector Capacitance (up to 30 pF) • Low Noise 3.7 pA/√Hz Equivalent Input Noise Current • Bandwidth DC ... 40 MHz • Transimpedance (Gain) 1 x 10⁵ V/A • Protection against ± 3.5 kV Transients 																																													
<p>Applications</p>	<ul style="list-style-type: none"> • Photodiode and Photomultiplier Amplifier • Spectroscopy • Charge Amplifier • Ionisation Detectors • Preamplifier for Lock-Ins, A/D Converters, etc. 																																													
<p>Specifications</p>	<table border="0"> <tr> <td></td> <td><i>Test Conditions</i></td> <td><i>V_s = ± 15 V, T_a = 25°C</i></td> </tr> <tr> <td rowspan="2">Gain</td> <td>Transimpedance</td> <td>1 x 10⁵ V/A (@ 50 Ω load)</td> </tr> <tr> <td>Gain Accuracy</td> <td>± 1 %</td> </tr> <tr> <td rowspan="4">Frequency Response</td> <td>Lower Cut-Off Frequency</td> <td>DC</td> </tr> <tr> <td>Upper Cut-Off Frequency (- 3 dB)</td> <td>40 MHz</td> </tr> <tr> <td>Rise / Fall Time (10 % - 90 %)</td> <td>10 ns</td> </tr> <tr> <td>Gain Flatness</td> <td>± 0.3 dB</td> </tr> <tr> <td rowspan="8">Input</td> <td>Equ. Input Noise Current</td> <td>3.7 pA/√Hz (@ 100 kHz)</td> </tr> <tr> <td>Equ. Input Noise Voltage</td> <td>0.8 nV/√Hz (@ 100 kHz)</td> </tr> <tr> <td>Input Bias Current</td> <td>18 μA typ.</td> </tr> <tr> <td>Input Bias Current Drift</td> <td>0.8 nA / K</td> </tr> <tr> <td>Offset Current Compensation</td> <td>± 20 μA adjustable by offset trimpot</td> </tr> <tr> <td>Input Current Range</td> <td>± 15 μA (for linear amplification)</td> </tr> <tr> <td>Input Offset Voltage</td> <td>3 mV</td> </tr> <tr> <td>DC Input Impedance</td> <td>50 Ω (virtual) // 5 pF</td> </tr> <tr> <td rowspan="2">Output</td> <td>Output Voltage Range</td> <td>± 1.5 V (@ 50 Ω load) for linear operation and low harmonic distortion</td> </tr> <tr> <td>Output Impedance</td> <td>50 Ω (terminate with 50 Ω load for best performance)</td> </tr> <tr> <td rowspan="2">Bias Output</td> <td>Bias Output Voltage Range</td> <td>± 12 V, adjustable by bias trimpot</td> </tr> <tr> <td>Bias Output Impedance</td> <td>10 kΩ // 1 μF</td> </tr> </table>			<i>Test Conditions</i>	<i>V_s = ± 15 V, T_a = 25°C</i>	Gain	Transimpedance	1 x 10 ⁵ V/A (@ 50 Ω load)	Gain Accuracy	± 1 %	Frequency Response	Lower Cut-Off Frequency	DC	Upper Cut-Off Frequency (- 3 dB)	40 MHz	Rise / Fall Time (10 % - 90 %)	10 ns	Gain Flatness	± 0.3 dB	Input	Equ. Input Noise Current	3.7 pA/√Hz (@ 100 kHz)	Equ. Input Noise Voltage	0.8 nV/√Hz (@ 100 kHz)	Input Bias Current	18 μA typ.	Input Bias Current Drift	0.8 nA / K	Offset Current Compensation	± 20 μA adjustable by offset trimpot	Input Current Range	± 15 μA (for linear amplification)	Input Offset Voltage	3 mV	DC Input Impedance	50 Ω (virtual) // 5 pF	Output	Output Voltage Range	± 1.5 V (@ 50 Ω load) for linear operation and low harmonic distortion	Output Impedance	50 Ω (terminate with 50 Ω load for best performance)	Bias Output	Bias Output Voltage Range	± 12 V, adjustable by bias trimpot	Bias Output Impedance	10 kΩ // 1 μF
	<i>Test Conditions</i>	<i>V_s = ± 15 V, T_a = 25°C</i>																																												
Gain	Transimpedance	1 x 10 ⁵ V/A (@ 50 Ω load)																																												
	Gain Accuracy	± 1 %																																												
Frequency Response	Lower Cut-Off Frequency	DC																																												
	Upper Cut-Off Frequency (- 3 dB)	40 MHz																																												
	Rise / Fall Time (10 % - 90 %)	10 ns																																												
	Gain Flatness	± 0.3 dB																																												
Input	Equ. Input Noise Current	3.7 pA/√Hz (@ 100 kHz)																																												
	Equ. Input Noise Voltage	0.8 nV/√Hz (@ 100 kHz)																																												
	Input Bias Current	18 μA typ.																																												
	Input Bias Current Drift	0.8 nA / K																																												
	Offset Current Compensation	± 20 μA adjustable by offset trimpot																																												
	Input Current Range	± 15 μA (for linear amplification)																																												
	Input Offset Voltage	3 mV																																												
	DC Input Impedance	50 Ω (virtual) // 5 pF																																												
Output	Output Voltage Range	± 1.5 V (@ 50 Ω load) for linear operation and low harmonic distortion																																												
	Output Impedance	50 Ω (terminate with 50 Ω load for best performance)																																												
Bias Output	Bias Output Voltage Range	± 12 V, adjustable by bias trimpot																																												
	Bias Output Impedance	10 kΩ // 1 μF																																												

High Speed Current Amplifier

Specifications (continued)		
Power Supply	Supply Voltage Supply Current	± 15 V ± 70 mA typ. (depends on operating conditions, recommended power supply capability minimum ± 150 mA)
Case	Weight Material	210 g (0.5 lbs) AlMg4.5Mn, nickel-plated
Temperature Range	Storage Temperature Operating Temperature	$-40 \dots +100$ °C $0 \dots +60$ °C

Absolute Maximum Ratings	Input Voltage Input Voltage Transient Power Supply Voltage	± 5 V ± 3.5 kV (pulsewidth 10 ns) ± 22 V
--------------------------	--	--

Connectors	Input Output Power Supply	BNC BNC LEMO series 1S, 3-pin fixed socket Pin 1: +15V Pin 2: -15V Pin 3: GND
------------	---------------------------------	--

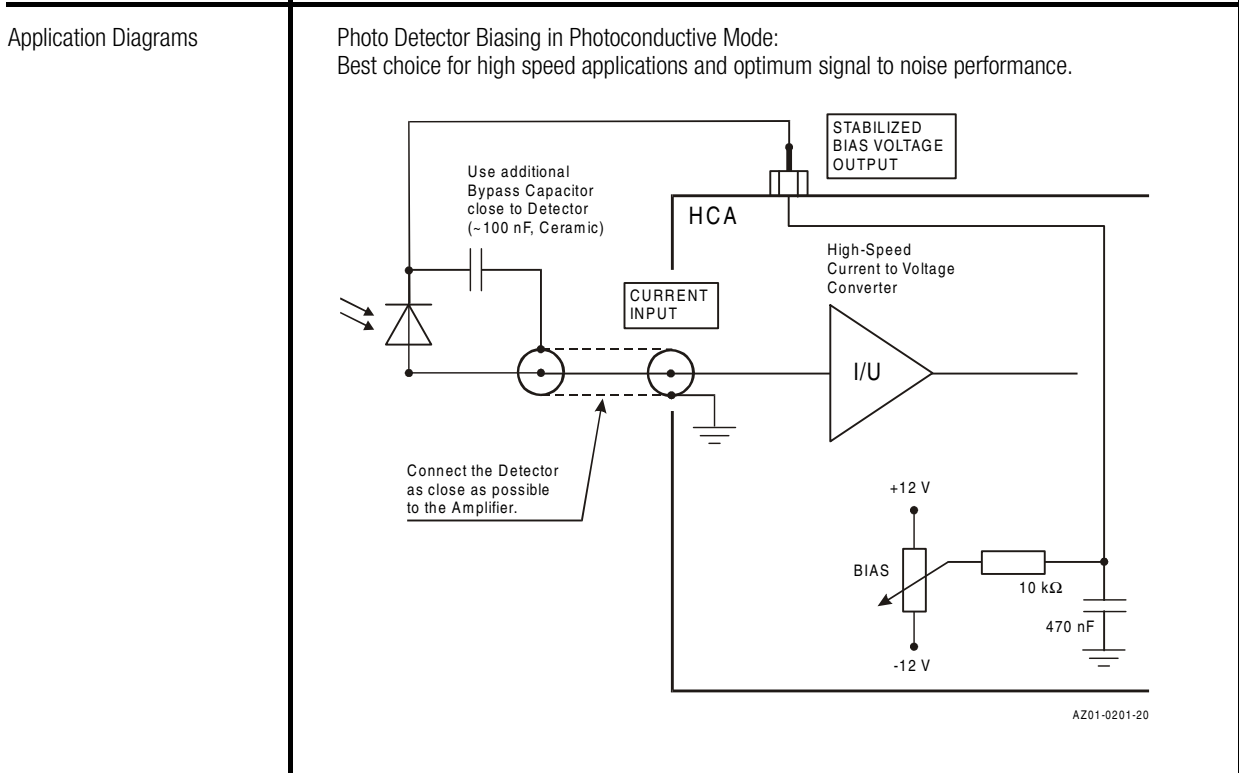
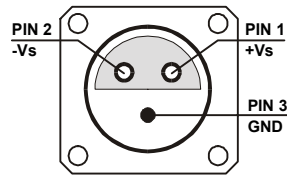

High Speed Current Amplifier

Dimensions

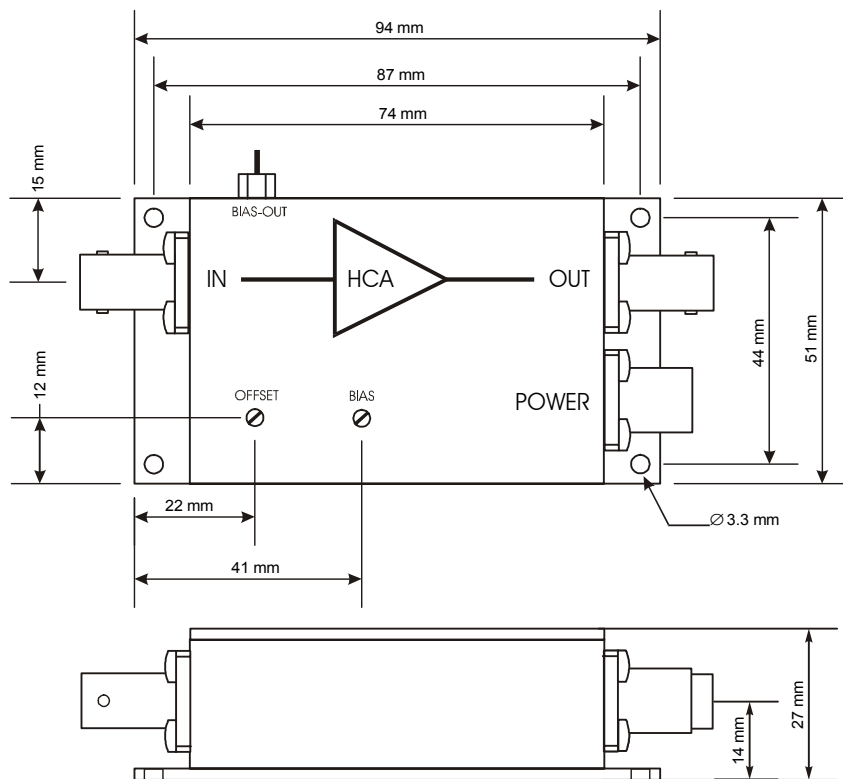

DZ01-0201-22

FEMTO Messtechnik GmbH
 Klosterstr. 64
 D-10179 Berlin · Germany
 Tel.: +49-(0)30-280 4711-0
 Fax: +49-(0)30-280 4711-11
 e-mail: info@femto.de
 http://www.femto.de

Specifications are subject to change without notice. Information furnished herein is believed to be accurate and reliable. However, no responsibility is assumed by FEMTO Messtechnik GmbH for its use, nor for any infringement of patents or other rights granted by implication or otherwise under any patent rights of FEMTO Messtechnik GmbH. Product names mentioned may also be trademarks used here for identification purposes only.
 © by FEMTO Messtechnik GmbH
 Printed in Germany